



## STEEL & GLASS EXTERIOR DOORS

The combination of steel frames and glass panels offers perfect synergy, providing strength, security, and an abundance of natural light.

Regardless of the design you select, these doors are the perfect option for varying architectural styles.

### MULTIPOINT LOCK ENHANCED SECURITY

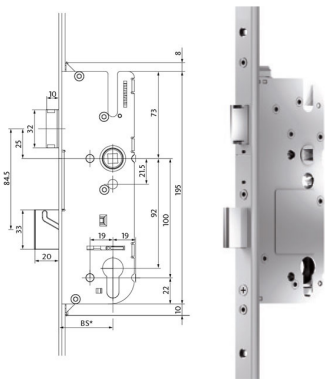

We employ a multi-point lock for enhanced security. For standard size systems, we utilize a precision engineered mortise iconic lock box, as shown above. On taller configurations, we leverage a 3 or 5 point locking system.

### COLOR OPTIONS SHADES TO COMPLEMENT

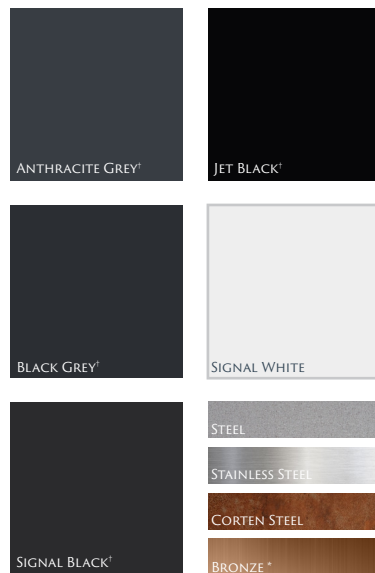

\*AVAILABLE IN SMOOTH AND TEXTURED

\* AVAILABLE IN BRONZE, MEDIUM BRONZE AND DARK BRONZE

### GLASS DIVIDED LITES TRUE DIVIDED AND SIMULATED

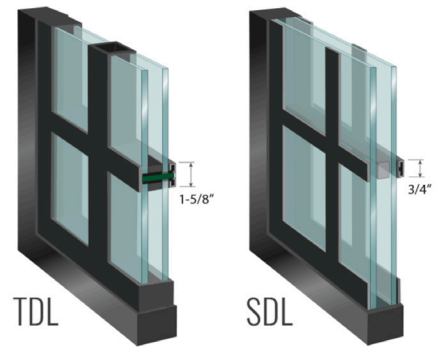

A divided lite gives the appearance of individual glass panes separated by muntins. True divided lites (TDL) use separate pieces of glass in each section, while simulated divided lites (SDL) mimic the look with a single pane and surface-applied grids. SDL offers similar style with better energy performance.



## DOOR DESIGNS

STANDARD AND CUSTOM CONFIGURATIONS  
FOR AN ARRAY OF MODERN DESIGN OPTIONS

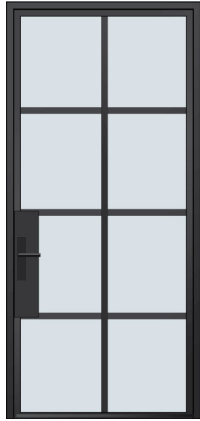

SINGLE  
EST-W8W

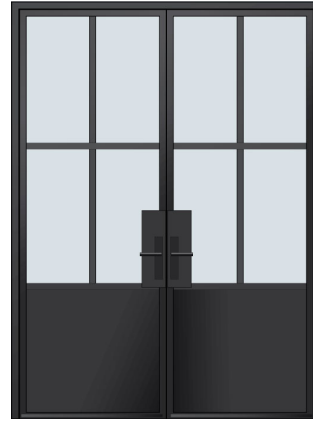

DOUBLE  
EST-W4P-DD

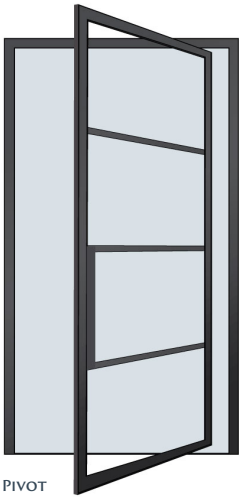

PIVOT  
EST-W4-PIVOT

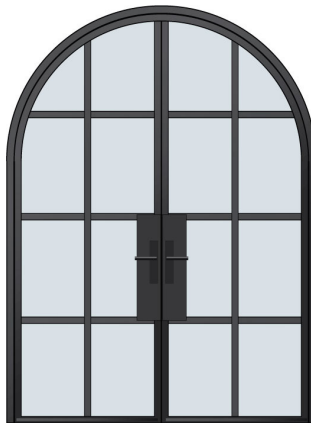

ARCHTOP  
EST-W8-ARCH



CUSTOM  
EST-W1-B2-PIVOT-CST

## HANDLES



ATHENA LEVER



HELIOS LEVER



HERMES LEVER



POSEIDON LEVER



STUGGART LEVER

\*ADDITIONAL OPTIONS AVAILABLE

